

Analog Sensors

Phidgets are the most user-friendly system available for controlling and sensing the environment from your computer. People with absolutely no hardware knowledge or experience can include things like light sensors and motion sensors into their projects. It is just a matter of plugging our off the shelf sensors into the PhidgetInterfaceKit 8/8/8, which in turn is plugged into the USB port on your computer. After that, you can use the simple to program Phidgets software libraries to access these devices.



A wide range of analog sensors are offered, all designed to plug into the PhidgetInterfaceKit 8/8/8 board. The PhidgetInterfaceKit 8/8/8 board can be controlled from Windows, Linux, and Mac OS X. High-level programming interfaces are available for Visual Basic, C, C++, Flash, .NET, Java, LabVIEW, etc.

What Can Analog Sensors Do?

Analog sensors measure continuous quantities, such as voltage, current, gas pressure, temperature, humidity, light, position, force, magnetic field, vibration, etc. There are many plug and play sensors in the Phidgets product line that require no assembly. Each sensor, which plugs into the PhidgetInterfaceKit 8/8/8, is described below.

Voltage Sensor

Measures DC voltages between -30 and +30 volts.

Type: Active
Board Dimensions: 3.1 x 3.8 cm
Mounting Holes: 2.3 x 3.0 cm
Formula: Voltage (in volts) =
(SensorValue - 500) x 0.06



Gas Pressure Sensor

This sensor uses an integrated silicon pressure sensor with on-chip signal conditioning, temperature compensation, and is calibrated.

This piezoresistive transducer is a state-of-the-art monolithic silicon pressure sensor designed for a wide range of applications. This transducer combines advanced micro-machining techniques, thin-film metallization and bipolar processing to provide an accurate, high-level analog output signal that is proportional to the applied pressure.

The sensor was initially designed for engine control to sense absolute air pressure within the intake manifold. This measurement can be used to compute the amount of fuel required for each cylinder.

Type: Active
Board Dimensions: 3.1 x 3.3 cm
Mounting Holes: 2.3 x 2.5 cm
Formula: Pressure (in kilopascals) = SensorValue x 0.25 + 10
Sensor: Motorola MPXA4250A



Rotation Sensor

This sensor rotates 300 degrees.

Type:	Resistive 3-Pin
Board Dimensions:	3.1 x 3.3 cm
Mounting Holes:	2.3 x 2.5 cm
Formula:	At fully clockwise the sensor reads zero, and at fully counter clockwise the sensor reads 1000. The maximum resistance of the potentiometer is 10 k ohm.
Sensor:	CTS Series 296



Touch Sensor

This sensor changes value from 1000 to 0 when it is touched. More specifically, this sensor is actually a capacitive change sensor. When the capacitance changes the sensor goes to zero. It will work through ¼ inch of glass.

Type:	Active
Board Dimensions:	3.1 x 3.8 cm
Mounting Holes:	2.3 x 3.0 cm
Sensor:	QProx QT110

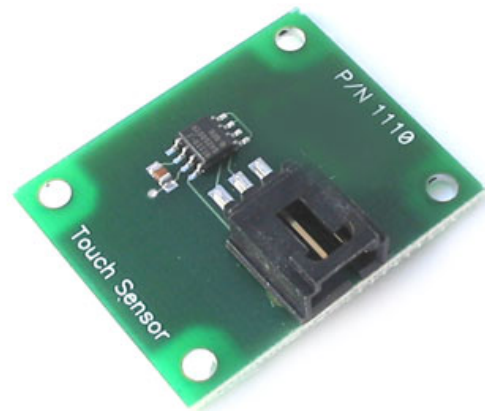

Motion Sensor

This motion sensor is a raw form of the on/off sensors used to trigger lights in security systems. They work by concentrating on a 15 degree cone in front of the sensor, and splitting this in two sections. The difference in infrared radiation of these two sections is amplified, and eventually cancelled out after several seconds. This differential allows you to get a sense of the size of the object (as viewed from the sensor), and the direction of travel.

The sensor quickly filters out noise and tracks to about 500 if nothing is moving. As it turns out, you can simulate movement by moving the sensor!

Type: Active
Board Dimensions: 4.2 cm (diameter) x 6.0 cm
Sensor: Glolab PIR325

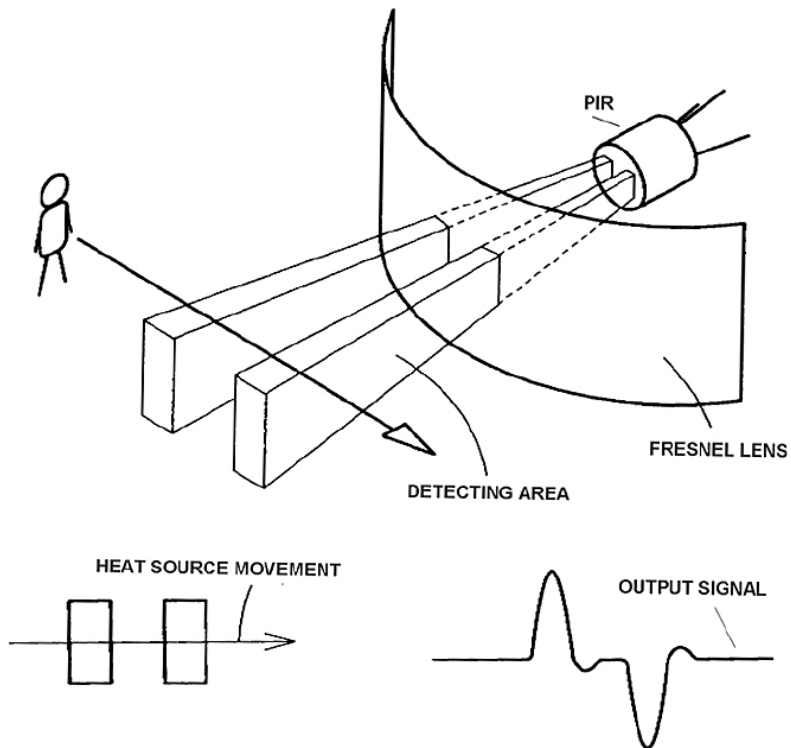
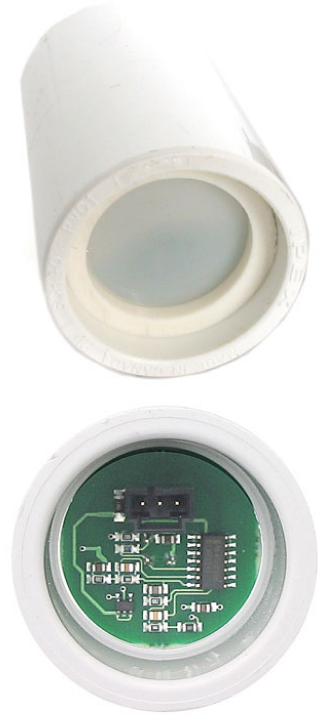

Slider 60

This device is a variable resistor similar to a potentiometer.

Type:	Resistive 3-Pin
Board Dimensions:	3.1 x 9.1 cm
Mounting Holes:	2.3 x 6.8 cm
Formula:	When the slider is at one side it will read zero and 1000 when the slider is at the other end. The maximum resistance of the slider is 10 k ohm.
Sensor:	Panasonic EWAQ1



Magnetic Sensor

This linear Hall-effect sensor is optimized, sensitive, and temperature- stable. It is a ratiometric Hall-effect sensor which provides a voltage output that is proportional to the applied magnetic field.

Type:	Active
Board Dimensions:	3.1 x 3.1 cm
Mounting Holes:	2.3 x 2.3 cm
Formula:	Magnetic flux density (in gauss) = 500 - SensorValue
Sensor:	Allegro MicroSystems A1321



Temperature Sensor

This sensor measures ambient temperature from -40 to $+125$ degrees Celsius. This device is a precision temperature to voltage converter that outputs a voltage that is directly proportional to temperature.

Type:	Active
Board Dimensions:	3.1 x 2.8 cm
Mounting Holes:	2.3 x 2.0 cm
Formula:	Temperature (in degrees Celsius) = (SensorValue - 200) / 4
Sensor:	Microchip TC1047A



Mini Joystick

This miniature joystick has two axes and a pushbutton. Each axis, up/down and left/right, has a potentiometer with a center value of approximately 500. When you move the Joystick from its center position the value will increase or decrease depending on the direction. Pressing down on the Joystick pin will make a momentary contact that can be connected to a digital input on the PhidgetInterfaceKit through the terminal blocks.

Type:	Resistive 3-Pin
Board Dimensions:	3.1 x 5.1 cm
Mounting Holes:	2.3 x 3.1 cm
Formula:	Max up is 1000, max down is 0.
Sensor:	CTS Series 252

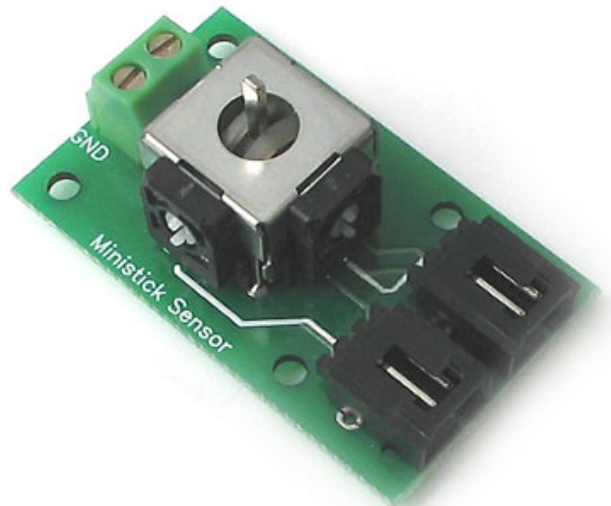

Multi-turn Rotation Sensor

This device is a multi-turn rotation sensor with 3600 degrees of rotation.

Type:	Resistive 3-Pin
Board Dimensions:	3.1 x 3.7 cm
Mounting Holes:	2.3 x 3.0 cm
Formula:	At fully clockwise the sensor reads zero, and at fully counter clockwise the sensor reads 1000. The maximum resistance of the potentiometer is 200 k ohm.
Sensor:	Bourns 3590 Precision Potentiometer



Light Sensor

In the dark, the value produced is approximately zero. As the amount of light increases, the value increases towards 1000.

Type:	Resistive 2-Pin
Board Dimensions:	3.1 x 2.8 cm
Mounting Holes:	2.3 x 2.1 cm
Formula:	With no light the resistance of this sensor is 500 k ohm. At 10 lux the resistance falls to between 10 k and 5 k ohm. This resistance is in a voltage divider with a 7.5 k ohm resistor.
Sensor:	A standard CdS (Cadmium Sulfide) photoresistor

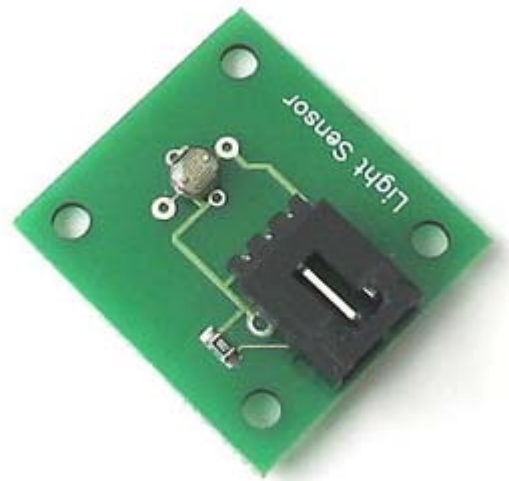

50 Amp Current Sensor

Measures AC up to 50 Amps and

DC current between -50 and +50 amps.

If the current being measured is AC then connect the sensor output labeled AC in this diagram to your Phidget device. If the current being measured is DC then use the output labeled DC. The AC output will give the RMS (Root Mean Square) value of an alternating current if the sine wave is varying equally across the zero point. The AC out can be used for signals that are not varying across proportionally around the zero point but the value will output will be the RMS plus a DC component. If a DC signal is being measured the AC out will produce a signal that can be used to calculate the current but without the value representing direction of current flow.

(Formulas

Type:	Active
Board Dimensions:	3.5 x 6.0 cm
Mounting Holes:	2.8 x 5.3 cm
Height of Sensor:	3.3 cm
Formula:	DC Current (in amps) = (SensorValue-500)x 0.125
	AC Current (in amps) = (SensorValue) x 0.0625
Sensor:	Allegro ACS754

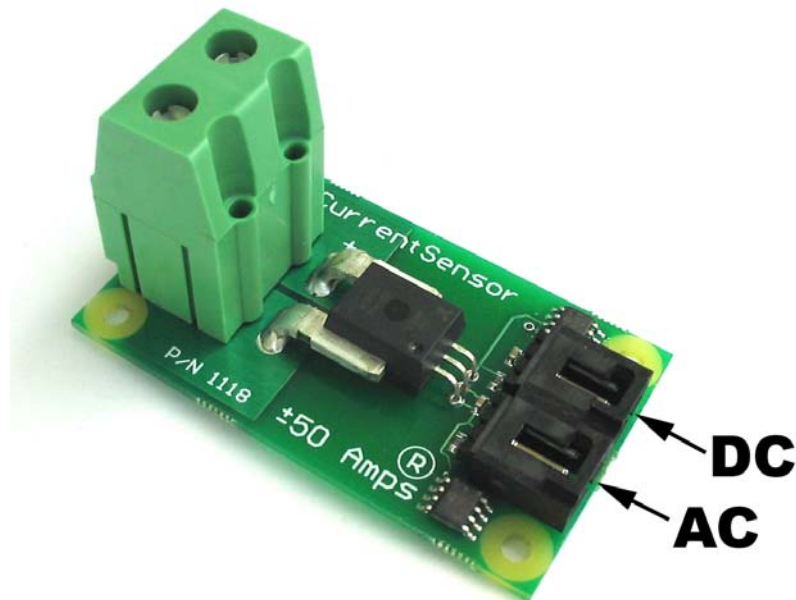

20 Amp Current Sensor

Measures AC up to 20 Amps and DC current between -20 and +20 Amps.

If the current being measured is AC then connect the sensor output labeled AC in this diagram to your Phidget device. If the current being measured is DC then use the output labeled DC. The AC output will give the RMS (Root Mean Square) value of an alternating current if the sine wave is varying equally across the zero point. The AC out can be used for signals that are not varying across proportionally around the zero point but the value will output will be the RMS plus a DC component. If a DC signal is being measured the AC out will produce a signal that can be used to calculate the current but without the value representing direction of current flow. (Formulas given apply to earlier 15 Amp Current Sensor)

Type: Active

Board Dimensions: 3.5 x 4.0 cm

Mounting Holes: 2.8 x 3.3 cm

Height of Sensor: 2.6 cm

Formula: DC Current (in amps) =
 $(\text{SensorValue} - 500) \times 0.05$
 AC Current (in amps) =
 $(\text{SensorValue}) \times 0.025$

Sensor: Allegro MicroSystems
 ACS706

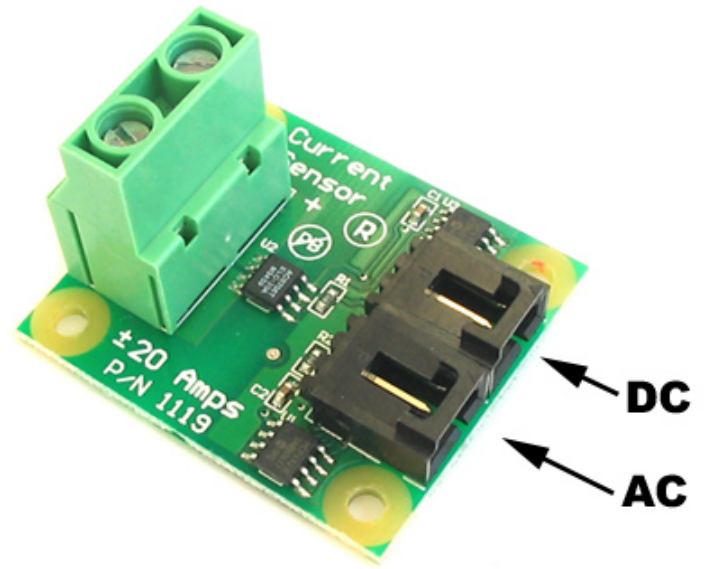

Humidity Sensor

This sensor measures the relative humidity of the environment around the sensor. Built in temperature compensation produces a linear output ranging from 10% to 95% relative humidity.

Type: Active

Board Dimensions: 3.1 x 5.0 cm

Mounting Holes: 2.3 x 4.3 cm

Formula: RH (in %) =
 $(\text{SensorValue} \times 0.1946) - 41.98$

Sensor: Humirel HTM1735



IR Reflective Sensor 5mm

This sensor can detect an object at 5mm. It can be used to determine the difference between black (low reflective conditions) and white (high reflective conditions).

Type:	Active
Board Dimensions:	3.0 x 3.9 cm
Mounting Holes:	2.3 x 3.1 cm
Sensor:	Fairchild QRB1114



IR Distance Sensor

This board is an adapter to interface the Sharp GP2D12 sensor to the PhidgetInterfaceKit 8/8/8. The Sharp GP2D12 measures distances from 70 cm to 10 cm. Sensor values from 0 to approximately 500 are produced, the output being approximately inversely proportional to the distance.

Because the Sharp GP2D12 can draw up to 300 mA for short periods of time, this board acts as a power filter. As long as these boards are used, up to eight Sharp GP2D12 sensors can be attached to the PhidgetInterfaceKit 8/8/8 at the same time.

Type:	Active
Board Dimensions:	3.0 x 3.0 cm
Mounting Holes:	2.3 x 2.3 cm
Sensor:	This is the interface board. The sensor is sold separately.



Force Sensor

With no force applied this sensor will read zero. As force increases on the circular button the value increases towards 1000. It is not accurate enough to be used as a weight measurement device. The sensor is not designed to have force applied constantly over time.

Type:	Resistive 2-Pin
Board Dimensions:	3.1 x 2.8 cm
Mounting Holes:	2.3 x 2.1 cm
Sensor:	CUI IESP-12



Vibration Sensor

This sensor buffers a piezoelectric transducer. As the transducer is displaced from the mechanical neutral axis, bending creates strain within the piezoelectric element and generates voltages. If the assembly is supported by its mounting points and left to vibrate "in free space" the device will behave as a form of vibration sensor. The sensing element should not be treated as a flexible switch, and is not intended to be bent.

Type:	Active
Board Dimensions:	3.0 x 3.0 cm
Mounting Holes:	2.3 x 2.3 cm
Sensor:	PUI AB2746B

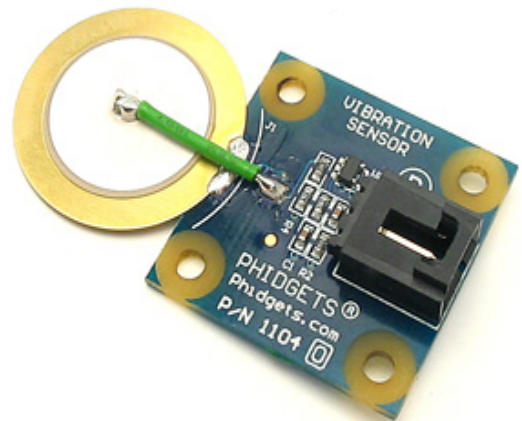

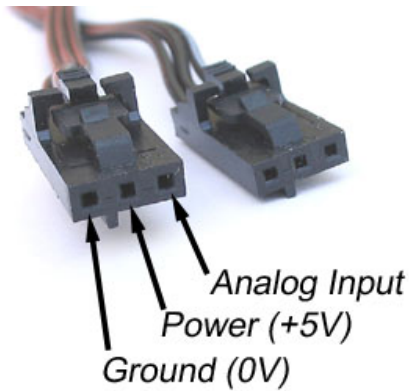

Using the Analog Inputs

While the off the shelf analog sensors will satisfy almost all needs, the occasional developer may want to include a sensor that is not available through Phidgets. Fortunately, this is still very easy to do, and only a rudimentary knowledge of electronics is needed. Read on!

Each analog sensor uses a 3-pin, 0.100 inch pitch locking connector. Pictured here is a plug with the connections labeled. If this is wired backwards, damage to your sensor may result. The PhidgetInterfaceKit 8/8/8 provides + 5 V DC, ground, and an analog input with a range of 0 to 5V.

The connector is manufactured by Molex, part number 50-57-9403 and 16-02-0102 for the wire crimp insert, and is available from many sources including www.DigiKey.com (Digi-Key part numbers WM2901-ND and WM2510-ND). If you want to create your own sensor boards than you can use one of the following Molex connectors on the circuit board: 70543-0002, 70553-0002, 70553-0037, 15-91-2035 (Digi-Key part numbers: WM4801-ND, WM4901-ND, WM4925-ND, WM1341-ND).

Types of Analog Sensor

Analog voltages can cause the greatest confusion when dealing with the PhidgetInterfaceKit 8/8/8. When working with electronics, the term "digital" means a signal is either on or off. Most of the time this translates to either 0 volts or 5 volts. However, the real world is a lot messier. When we want to measure anything we tend to get a voltage level that varies between 0 volts and some preset maximum. With the PhidgetInterfaceKit 8/8/8 we can measure voltages that vary between 0 volts and 5 volts. How we generate this voltage depends on the type of sensor, whether it is resistive or active. Phidgets has three types of analog sensor:

Resistive Sensors – Three Pin

A variable resistor can produce a varying voltage when it is connected correctly. We configure these sensors as a "voltage dividers". In the diagram below shows a schematic of a variable resistor that is similar to the slider or rotation sensor (the mini joystick is actually two rotation sensors) described above.

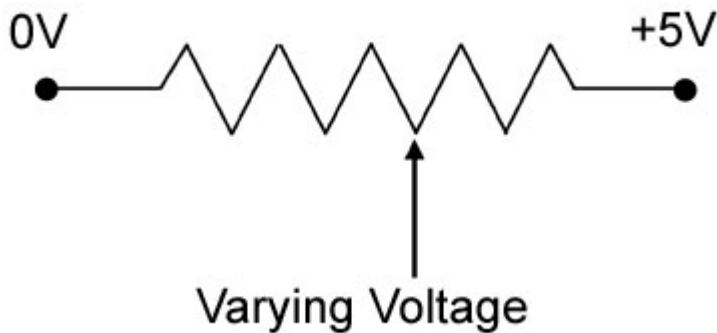

Usually this type of device has three connections. If you measured the resistance across the two outer terminals it would be constant. The resistance between the middle terminal and either of the outer terminals varies. In the image of the potentiometer, the red wire is the + 5 volts, the black wire is Ground, and the green wire is the analog signal.

Unfortunately we need to do a bit of math to explain how easy it is to use varying resistors. The golden rule for electricity is Ohm's Law; voltage (V) equals current (I) times resistance (R).

Ohm's Law

Voltage = Current x Resistance

$$V = I \times R, \quad I = \frac{V}{R}, \quad R = \frac{V}{I}$$

Don't panic, we won't have to worry about all of the terms here once we do a little algebra (no wait don't go away, it will be okay). Let's start by picking a point along the resistor and calling that 'A'. The current along any point in the resistor is constant – current in equals current out – so we can do the following math:

$$I_A = I_{\text{Total}} \quad \frac{V_A}{R_A} = \frac{V_{\text{Total}}}{R_{\text{Total}}}$$

We rearranged Ohm's Law to get current by itself and substituted. Next let's rearrange to get the voltage at point 'A' by itself. We do this because the voltage is what we are going to measure. For this example we are going to take point 'A' at 25% along the resistor.

$$V_A = \frac{R_A}{R_{\text{Total}}} V_{\text{Total}} = \frac{25\% R_{\text{Total}}}{R_{\text{Total}}} V_{\text{Total}}$$

Now we can simplify. We can see that the voltage at point 'A' does not require the total resistance to be known, only how far along the resistor we are, in this case we chose 25%.

$$V_A = 25\% V_{Total}$$

Since the PhidgetInterfaceKit 8/8/8 has a maximum voltage of 5 volts, the voltage at point 'A' would be $25\% \times 5 = 1.25$ volts.

Resistive Sensors – Two Pin

Sometimes a variable resistor has only two terminals. The resistance changes as a result of some other external condition, like the force sensor or light sensor (the vibration sensor is similar to the force sensor). In this case we create a voltage divider using another constant resistor that is much smaller than the maximum value of the varying resistor. In the image below of the light sensor and the constant resistor, the red wire is the + 5 volts, the black wire is Ground, and the green wire is the analog signal.

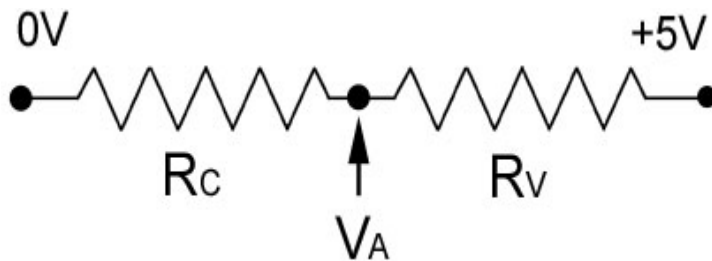
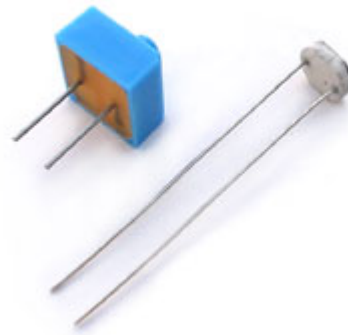

Here, our variable resistor is R_v and our constant resistor is R_c . Our measurement point 'A' is at the connection between the two resistors. Again let's start with the Ohm's Law:

$$I_A = I_{Total} \quad \frac{V_A}{R_A} = \frac{V_{Total}}{R_{Total}}$$

This time we will use a different substitution. Since the total resistance is $(R_c + R_v)$, the constant resistance plus the varying resistance, we get:

$$V_A = \frac{R_A}{R_{Total}} V_{Total} = \frac{R_C}{R_C + R_V} V_{Total}$$

When R_V has a maximum value, such as 1,000,000 ohms (ohms are the units of Resistance), we get a measured voltage of approximately zero. When R_V has a minimum value of 0 ohms then we get a measured voltage equal to V_{Total} , and in our case V_{Total} is 5 volts.

That's all there is to measuring the voltage across a variable resistor.

Active Sensors

The other type of sensor available is one that produces a voltage without relying on a varying resistance. In this case the sensor usually requires a power connection be made to the 5 volt line and a ground connection to the 0 volt line. The varying voltage can range from 0 volts to a maximum of 5 volts. However, if the sensor only produces a voltage between 0 and 2.5 volts it can still be used with the PhidgetInterfaceKit 8/8/8. The Temperature, Touch, and Motion Sensors are active sensors, and the Dual-Axis Accelerometer has two active sensors.

Accuracy and Analog to Digital Conversion

The PhidgetInterfaceKit 8/8/8 reads the analog input voltage and converts it to an integer number. Currently a 10-bit analog to digital converter (ADC) is used. This means that between 0 volts and 5 volts there are 1024 discrete steps. The measured voltage is then compared to these steps and the closest "step" is given as the result. There can be a loss in accuracy (called quantization noise), and this depends on the size of the step. So more steps are obviously better, right? Well, maybe.

The precision of the 10-bit ADC is approximately 5 millivolts. This means that the maximum error in measuring your voltage will be only 2.5 millivolts. But this isn't the only source of error. There are 1024 steps between 0 volts and 5 volts, but how accurate are the values of 0 and 5? This starts getting into some basic physics so if you're getting bored you should stop reading now and go and do something cool with your Phidgets.

To make use of an ADC with high accuracy several questions need to be asked:

- How stable is my sensor; is there any thermal drift over time?
- Is there a voltage difference from the 5 V reference; exactly what is at 5 volts?
- How accurate is my 5 V reference, and how stable is my ground?
- Is my code averaging the result anyway?
- Does the calibration of my sensor affect the measured voltage?

For extremely accurate measurements, special consideration must be made to all aspects of the design.

Calibrating Sensors

We try to make the sensors we sell as accurate as possible. Some of the sensors, like the PhidgetWeightSensor, PhidgetTemperatureSensor have the ability to correct for their own errors using an onboard processor. Other sensors, like the pressure sensor or voltage sensor, do not have this capability. Instead, we use the most accurate components that are economically practical. This means that the sensors can have a error of up to several percent. For many applications this is good enough. Those who need better accuracy from their Phidgets have to perform their own calibration.

We provide formulae for the sensors, but these assume no error. If the formula doesn't work for you, you have to calculate a new formula that takes into account the peculiarities of your device. Our sensors have a fairly linear output, meaning you only need two data points to derive an accurate formula.

Assuming that you are calibrating the voltage sensor, the first data point is acquired by grounding the voltage input to the voltage sensor ground. Take the reading from the software, possibly using one of our example programs like interfacekit-controller.exe. Say the first reading is 510. You need a second data point so, in the case of the voltage sensor, you need to apply a known voltage, say 14 V. Take the second reading from the software, say it is 720.

Now derive equations from your known values:

$$\text{Voltage} = A \times \text{SensorValue} + B, \text{ where } A \text{ and } B \text{ are constants}$$

Substituting the two data points, we get:

$$0 = A \times (510) + B$$

$$14 = A \times (720) + B$$

Solving for A and B gives:

$$A = 0.066667$$

$$B = -34.00$$

So, your formula is:

$$\text{Voltage} = 0.06667 \times \text{SensorValue} - 34.00,$$

where SensorValue is the 0 to 1000 analog Input voltage.

Another point to ponder:

The PhidgetInterfaceKit 8/8/8 introduces a 1% error as well. One should note the above calibration also takes into account the error of the Interface Kit. That is, the same sensor with the same formula using a different PhidgetInterfaceKit 8/8/8 will no longer be as accurate.