

1143_0 Mechanical Drawing

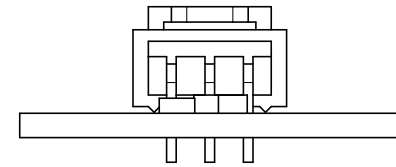
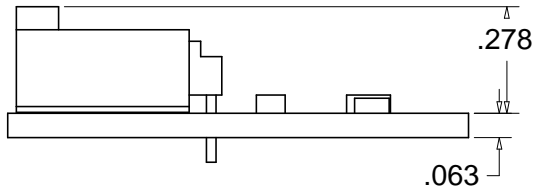
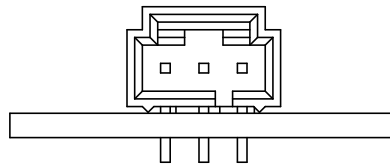
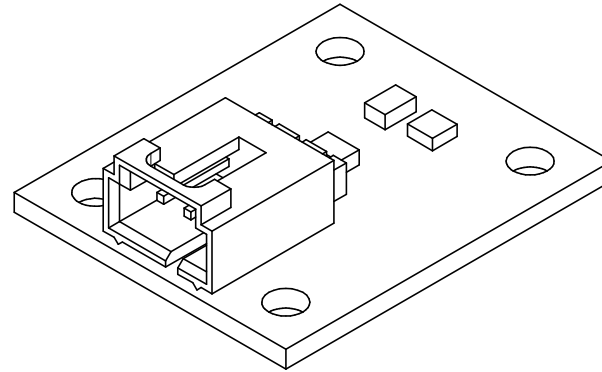
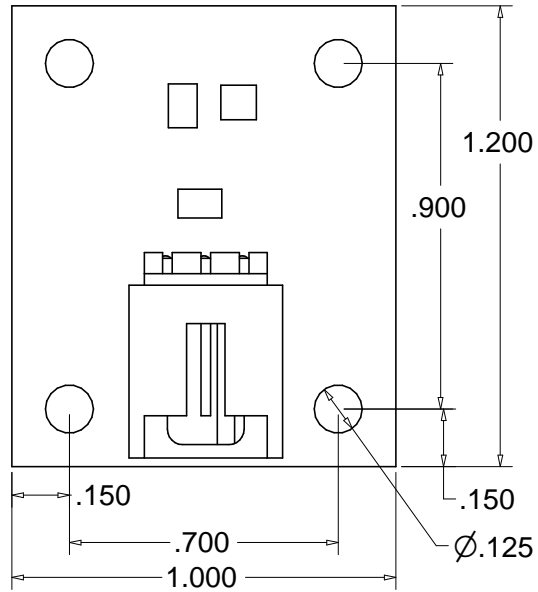

Scale 2:1
Units are in Inches