

1145_0 Mechanical Drawing

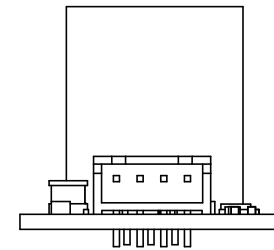
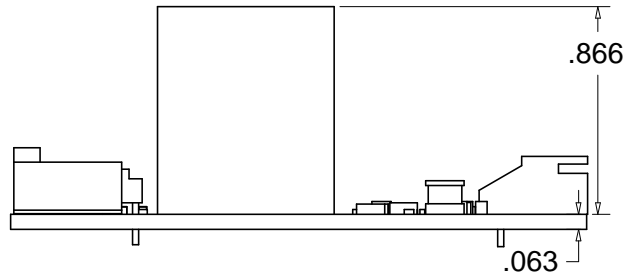
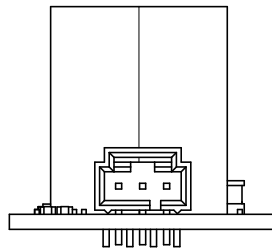
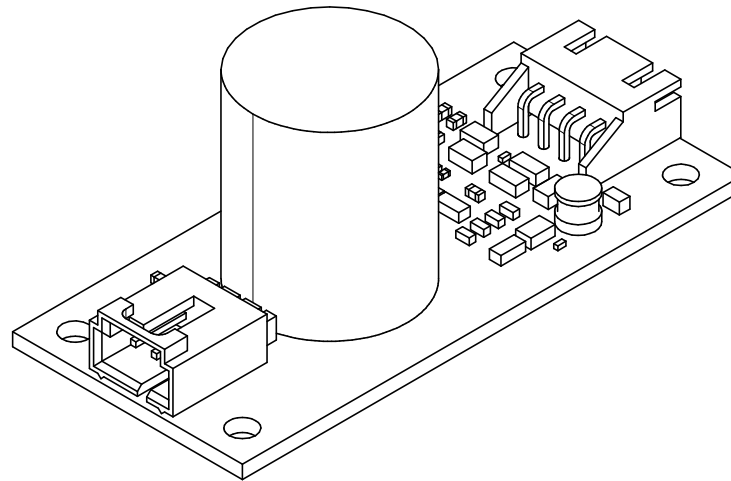
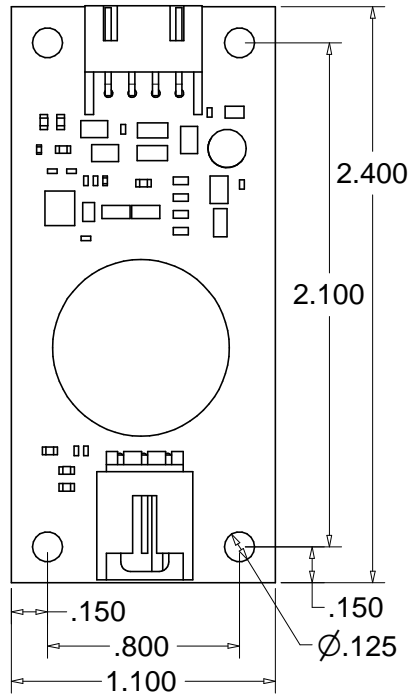

Scale 1: 0.8
Units are in Inches